

Project: \_\_\_\_\_

Fixture Type: \_\_\_\_\_ Quantity: \_\_\_\_\_

Customer: \_\_\_\_\_

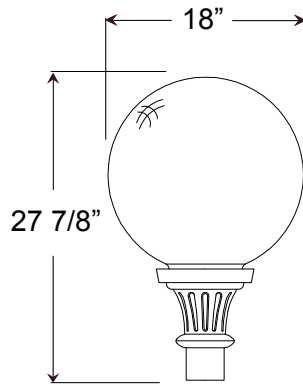

**Specifications**

**Fitter:**  
Fitter is durable 356 cast aluminum. All hardware provided shall be stainless steel or zinc plated steel.

**Round Globe:**  
Round Globes are available in clear, frosted and white polycarbonate material.

**Fixture Mounting:**  
Post Mount: Post Cap with set screws. Fits 3" and 4" poles.

**Drivers:**  
Universal voltage 120-277 is standard. 0-10V, TRIAC and ELV dimming to 1% protocols are standard for LED modules.

See page 2 table for LED module and driver specs, voltage and dimming protocols



**Electrical:**  
Approximately 12" of pull wire extends from luminaire. Additional pull wire provided for post mount arms and wall mounts.

**Finish:**  
A polyester powder coat high quality finish is electro-statically applied and baked at 430° for exceptional durability and color retention. Products undergo an intensive five-step cleansing and pretreatment process for maximum paint adhesion.

Marine grade finish provides superior salt, humidity and UV protection. This coating withstands up to 3000 hours of continuous salt spray, comes with a 5-year warranty and is available in either a textured or gloss surface.

**Modifications:**  
Consult factory for custom or modified designs.

**LF3218**

**Weight:** 19.5 lbs  
**EPA:** 1.16

**LED**

**Catalog Logic**  
**LF3218** **95** **CL** **M016LD** **D** **T5** **40K** **- PC** **- FIN02** **- WM2141** **- 72**  
 Luminaire Series    Cage    Lens    Light Source & Wattage    Dimming    Optic    CCT    Accessories    Finial    Mounting    Finish

**Catalog Number**

1	2	3	4	5	6	7	8	9	10
<b>LF3218</b>			<b>D</b>						

**1 OPTIONAL CAGE**  
See Page 3 for Style/Design

**CAGE:** 95

**2 LENS**

**CL** (Clear Polycarbonate Sphere)  
**FR** (Frosted Polycarbonate Sphere)  
**WH** (White Polycarbonate Sphere)

**3 LIGHT SOURCE & WATTAGES**

<b>M009LD</b>	( 9w, 850 lumen, Cree module)
<b>M010LD</b>	(10w, 1250 lumen, Cree module)
<b>M012LD</b>	(12w, 750 lumen, Cree module) Integral driver, 120V, Triac dimming & narrow distribution only.
<b>M016LD</b>	(16w, 2000 lumen, Cree module)
<b>M024LD</b>	(24w, 3000 lumen, Cree module)

**4 DIMMING**

**D** (Dimming)

See page 2 for LED Module dimming protocols and limitations.

**5 OPTICS**

**W** (T5 Wide Distribution with Dome LED Lens)  
**N\*** (T5 Narrow Distribution with Flat LED Lens)

\*12w is narrow only, select "N".

**6 COLOR TEMPERATURE (CCT)**

Module	
<b>27K</b>	(2700K)
<b>30K</b>	(3000K)
<b>35K</b>	(3500K)
<b>40K</b>	(4000K)

**7 ACCESSORIES**

**HSS90** (90° House Side Shield, polished)  
**HSS120** (120° House Side Shield, polished)  
**PHSS90** (90° House Side/Uplight Shield, polished)  
**PHSS120** (120° House Side/Uplight Shield, polished)  
**\*EMG-LED5** (5w, LED Emergency Driver, remote placement, Cree module only)  
**\*EMG-LED7** (7w, LED Emergency Driver, remote placement, Cree module only)  
**\*EMG-LED10** (10w, LED Emergency Driver, remote placement, Cree module only)  
**HLMSPC-06** (High-Low Motion Sensor/Photocell; 15' - 30' Sensor Mounting Height)  
**HLMSPC-10** (High-Low Motion Sensor/Photocell; 8' - 15' Sensor Mounting Height)  
**PC** (Button Photo Cell)  
**RNR** (Reinforcing Neck Ring)  
**SP** (Surge Protector, 10kA & 10kV)  
**TLPC** (Twist Lock photo cell, includes receptacle & photo cell)  
**TL** (Twist Lock receptacle only)  
**TL5** (5-pin Twist Lock receptacle)  
**TL7** (7-pin Twist Lock receptacle)

\*For Emergency lumen output data, see Resources section at [www.ANPlighting.com](http://www.ANPlighting.com).

**8 OPTIONAL FINIALS**

\*See Page 4 for Style/Size

**FIN02, FIN04, FIN05, FIN06, FIN10, FIN12, FIN15, FIN18, FIN28, FIN39, FIN41, FIN42, FIN48, FIN64, FIN70**

**9 MOUNTING SOURCE**

Post Mount Arms *See Page 4 for Style/Size		Wall Mount Arms *See Page 4 for Style/Size	
<b>PA5151</b>	<b>PA8711</b>	<b>WM2141</b>	<b>WM8581</b>
<b>PA5171</b>	<b>PA8831</b>	<b>WM2211</b>	<b>WM8831</b>
<b>PA5411</b>		<b>WM3351</b>	
<b>PA5621</b>		<b>WM4511</b>	
<b>PA5651</b>		<b>WM5131</b>	
<b>PA6211</b>		<b>WM5161</b>	
<b>PA7911</b>		<b>WM5311</b>	
<b>PA8031</b>		<b>WM5601</b>	
<b>PA8521</b>		<b>WM7411</b>	
<b>PA8571</b>		<b>WM8011</b>	
Column Mount *See Page 4 for Style/Size			
<b>CM</b>	Column Mount		

**10 FINISHES**

Standard Grade	Marine Grade	Standard Grade	Marine Grade
<b>40</b>	<b>NA</b> Raw Unfinished	<b>53</b>	<b>100</b> Copper Clay
<b>41</b>	<b>101</b> Black	<b>56</b>	<b>109</b> Silver
<b>42</b>	<b>102</b> Forest Green	<b>61</b>	<b>106</b> Black Verde
<b>43</b>	<b>114</b> Bright Red	<b>70</b>	<b>118</b> Painted Chrome
<b>44</b>	<b>107</b> White	<b>71</b>	<b>105</b> Painted Copper
<b>45</b>	<b>112</b> Bright Blue	<b>72</b>	<b>108</b> Textured Black
<b>46</b>	<b>123</b> Sunny Yellow	<b>73</b>	<b>125</b> Matte Black
<b>47</b>	<b>120</b> Aqua Green	<b>76</b>	<b>121</b> Textured Architectural Bronze
<b>49</b>	<b>NA</b> Galvanized	<b>77</b>	<b>127</b> Textured White
<b>50</b>	<b>111</b> Navy	<b>78</b>	<b>124</b> Textured Silver
<b>51</b>	<b>103</b> Architectural Bronze	<b>10</b>	<b>130</b> Aspen Green
<b>52</b>	<b>104</b> Patina Verde	<b>11</b>	<b>131</b> Cantaloupe
<b>12</b>	<b>133</b> Lilac	<b>13</b>	<b>132</b> Putty

Consult factory for additional paint charges and availability

Project: \_\_\_\_\_  
 Fixture Type: \_\_\_\_\_ Quantity: \_\_\_\_\_  
 Customer: \_\_\_\_\_

LED PERFORMANCE				
MODULE				
LED Wattage	CCT	Typical Luminous Flux	System Wattage	Typical Efficacy
9W	2700K	850	11W	97
	3000K	850	11W	97
	3500K	850	11W	97
	4000K	850	11W	97
10W	2700K	1250	12W	125
	3000K	1250	12W	125
	3500K	1250	12W	125
	4000K	1250	12W	125
12W	2700K	750	12W	65
	3000K	750	12W	65
	3500K	750	12W	65
	4000K	750	12W	65
16W	2700K	2000	19W	125
	3000K	2000	19W	125
	3500K	2000	19W	125
	4000K	2000	19W	125
24W	2700K	3000	28W	125
	3000K	3000	28W	125
	3500K	3000	28W	125
	4000K	3000	28W	125

MODULE SPECIFICATION
<ul style="list-style-type: none"> <li>Efficacy 65-125 lumens per watt</li> <li>Life: L70 50,000 hours</li> <li>Color temp: 2700K,3000K,3500K and 4000K</li> <li>CRI: &gt;90</li> </ul>

MODULE LISTINGS
<ul style="list-style-type: none"> <li>Fully compliant with the RoHS Directive</li> <li>Certifications: CE/UL</li> </ul>

MODULE DRIVER SPECIFICATION
<ul style="list-style-type: none"> <li>Input Voltage: 120-277 Volts; 50/60Hz</li> <li>Dimmable down to 1%</li> <li>0-10V, TRIAC and ELV dimming protocols are standard.</li> <li>Output Current: Constant Current: 440mA to 940mA (model dependent)</li> <li>Driver Efficiency &gt; 80%; Power Factor &gt; 0.9</li> <li>Integral Surge Protection in conformance to ANSI C62.41 Category A</li> </ul>

WARRANTY
See <a href="http://www.ANPlighting.com">www.ANPlighting.com</a> for complete fixture warranty. • 5 year limited warranty on Modules/Drivers  *Limited Warranty: A typical year is defined as 4380 hours of operation.

Project: \_\_\_\_\_  
Fixture Type: \_\_\_\_\_ Quantity: \_\_\_\_\_  
Customer: \_\_\_\_\_

## CAGE



CAGE 95

## ACCESSORIES



HSS90 & HSS120



PHSS90 & PHSS120



EMG-LED 5w/7w/10w



HLMSPC-06 & HLMSPC-10



PC



RNR



TLPC



TL



TL5 & TL7

Project: \_\_\_\_\_

Fixture Type: \_\_\_\_\_ Quantity: \_\_\_\_\_

Customer: \_\_\_\_\_

**FINIALS**

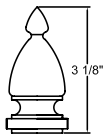

**FIN02**

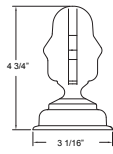

**FIN04**

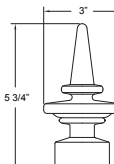

**FIN05**

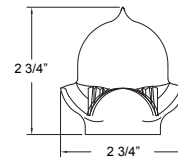

**FIN06**

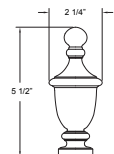

**FIN10**

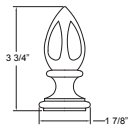

**FIN12**

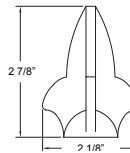

**FIN15**

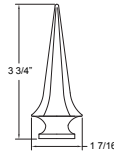

**FIN18**

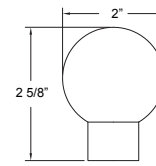

**FIN28**

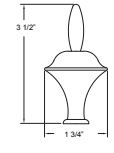

**FIN39**

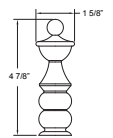

**FIN41**

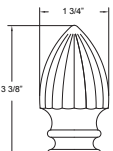

**FIN42**

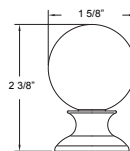

**FIN48**



**FIN64**

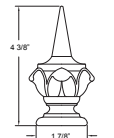

**FIN70**

**POST MOUNTS** - See Post Arm Section on Website for Specification Sheets and additional post arms. Dimensions are Projection x Height



**PA5151** / 14 1/4" x 19 3/4"



**PA5171** / 15 1/4" x 25 5/8"



**PA5411** / 17 7/8" x 25 1/8"



**PA5621** / 19" x 26 1/4"



**PA5651** / 20" x 26 1/4"



**PA6211** / 22 3/4" x 26 1/2"



**PA7911** / 20" x 20 5/8"



**PA8031** / 20 1/2" x 20 1/4"



**PA8521** / 18 1/4" x 14 1/2"



**PA8571** / 24" x 47"



**PA8711** / 20" x 20 3/8"



**PA8831** / 18 7/8" x 18 7/8"

**COLUMN MOUNT**



**CM** / 5 3/4" SQ x 3 1/2" H

**WALL MOUNTS** - See Wall Mount Section on Website for Specification Sheets and additional wall mount arms. Dimensions are Projection x Height.

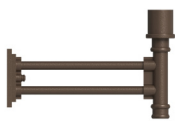

**WM2141** / 18" x 12 3/16"



**WM2211** / 15 1/2" x 15 7/8"



**WM3351** / 14 1/2" x 22"

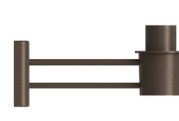

**WM4511** / 17" x 8"



**WM5131** / 11" x 16 3/8"



**WM5161** / 15 3/4" x 17 3/4"



**WM5311** / 10 7/8" x 9 3/4"



**WM5601** / 17 7/8" x 14"



**WM7411** / 14" x 15 3/4"



**WM8011** / 18 1/4" x 16 3/8"



**WM8581** / 17 1/8" x 17 1/2"



**WM8831** / 17 1/4" x 16 3/8"