

**BBU22**

200w Max Incandescent  
22" Contempo Bistro

Weight: 6.2 lbs

Project: \_\_\_\_\_

Fixture Type: \_\_\_\_\_ Quantity: \_\_\_\_\_

Customer: \_\_\_\_\_



illuminating  
ENGINEERING SOCIETY

**Specifications**

**Material:**  
Shade is 0.80" spun aluminum. Cast Aluminum Hub and Wall Canopy

**Electrical:**  
Medium Base Socket, 200w Max and 120v only.

**Certifications:**  
Cord mounts are UL listed for dry locations. Arm mount are UL listed for wet locations.

**Finish:**  
A polyester powder coat high quality finish is electro-statically applied and baked at 430° for exceptional durability and color retention. Products undergo an intensive five-step cleansing and pretreatment process for maximum paint adhesion.

Marine grade finish provides superior salt, humidity and UV protection. This coating withstands up to 3000 hours of continuous salt spray, comes with a 5-year warranty and is available in either a textured or gloss surface.

**Modifications:**  
Consult factory for custom or modified designs.

**Catalog Logic**

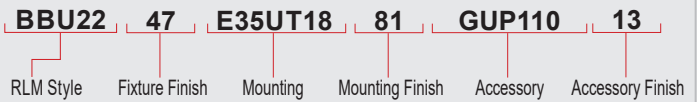

**Catalog Number**



1		3		5		FINISHES			
Standard Grade	Marine Grade	Standard Grade	Marine Grade	Standard Grade	Marine Grade	Standard Grade	Marine Grade	Standard Grade	Marine Grade
40	NA	Raw Unfinished	53	100	Copper Clay				
41	101	Black	56	109	Silver				
42	102	Forest Green	61	106	Black Verde				
43	114	Bright Red	70	118	Painted Chrome				
44	107	White	71	105	Painted Copper				
45	112	Bright Blue	72	108	Textured Black				
46	123	Sunny Yellow	73	125	Matte Black				
47	120	Aqua Green	76	121	Textured Architectural Bronze				
49	NA	Galvanized	77	127	Textured White				
50	111	Navy	78	124	Textured Silver				
51	103	Architectural Bronze	10	130	Aspen Green				
52	104	Patina Verde	11	131	Cantaloupe				
12	133	Lilac	13	132	Putty				
Premium Grade	Marine Grade	Premium Grade	Marine Grade	Premium Grade	Marine Grade	Premium Grade	Marine Grade	Premium Grade	Marine Grade
81	129	Extreme Chrome	64	116	Candy Apple Red				
80	117	Textured Desert Stone	65	122	Cobalt Blue				
67	119	Butterscotch	82	128	Graystone				
66	115	Caramel	69	113	Gunmetal Gray				
68	126	Black Silver	83	134	Oil Rubbed Bronze				

Consult factory for additional paint charges and availability

**WARRANTY**

See [www.ANPlighting.com](http://www.ANPlighting.com) for complete fixture warranty

2		MOUNTING	
Arm Mounts			
E31UT18			
E33UT22			
E35UT18			
Cord Mounts			
BLCUT	(6' black cord, UT cast hub & 5 1/4" x 2 3/4" canopy)		
WHCUT	(6' white cord, UT cast hub & 5 1/4" x 2 3/4" canopy)		
XXXXUT	(6' color cord, UT cast hub & 5 1/4" x 2 3/4" canopy. Replace XXXX with color cord designation from page 3.)		

4		ACCESSORIES	
GUP110	(Wire lamp guard)		
GUP120	(Wire lamp guard)		
TCPG	(Grey, braided cord cover)		

Project: \_\_\_\_\_

Fixture Type: \_\_\_\_\_ Quantity: \_\_\_\_\_

Customer: \_\_\_\_\_



**Illuminating**  
ENGINEERING SOCIETY

**PENDANT MOUNTS**

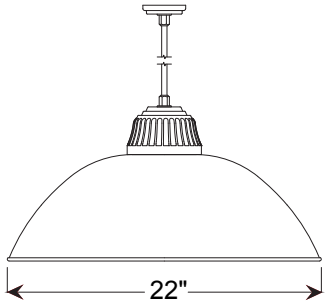

**BBU22-BLCUT**

**ARM MOUNTS**

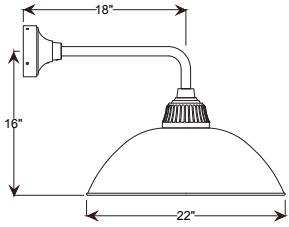

**BBU22-E31UT18**

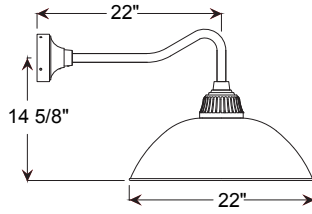

**BBU22-E33UT22**

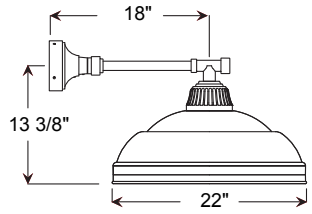

**BBU22-E35UT18**

**ACCESSORIES**

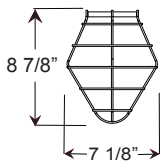

**GUP110**

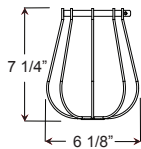

**GUP120**

Project: \_\_\_\_\_  
 Fixture Type: \_\_\_\_\_ Quantity: \_\_\_\_\_  
 Customer: \_\_\_\_\_

All fabric Color Cords are three conductor, 1/4" diameter

**Solid Fabric Colored Cords**



**BLSF** | Black



**GYSF** | Gray



**CHSF** | Chocolate Brown



**WHSF** | White

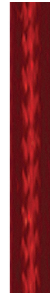

**CASF** | Cardinal



**ORSF** | Orange



**LGSF** | Lime Green



**KGSF** | Kelly Green



**CBSF** | Cobalt Blue



**SBSF** | Sky Blue

**Patterned Fabric Colored Cords**



**BWHPF** | Black/White Houndstooth



**BIHPF** | Houndstooth



**GYCPF** | Gray/Citrus Yellow



**MOSPF** | Magenta/Orange Stripe



**NMTPF** | Navy Mini Tweed

**Glossy Fabric Colored Cords**



**GMGF** | Gun Metal



**SSGF** | Sterling Silver



**CPGF** | Copper Penny



**BRGF** | Bronze



**GOGF** | Gold