

Project: \_\_\_\_\_

Fixture Type: \_\_\_\_\_ Quantity: \_\_\_\_\_

Customer: \_\_\_\_\_

### Specifications

**Material:**  
Shade is 0.80" spun aluminum. Cap and Lens ring are 356 cast aluminum. All fasteners are stainless steel. Inside of shade is reflective white finish for all colors except galvanized paint finish. Screw hardware may not match paint.

**Electrical:**  
Medium Base Socket and 120v.

**Certifications:**  
Cord mounts are UL Listed for dry locations. Arm mount, stem mount and wall mount are UL Listed for wet locations.



**Illuminating**  
ENGINEERING SOCIETY

**Finish:**  
A polyester powder coat high quality finish is electro-statically applied and baked at 430° for exceptional durability and color retention. Products undergo an intensive five-step cleansing and pretreatment process for maximum paint adhesion.

Marine grade finish provides superior salt, humidity and UV protection. This coating withstands up to 3000 hours of continuous salt spray, comes with a 5-year warranty and is available in either a textured or gloss surface.

**Modifications:**  
Consult factory for custom or modified luminaires.

## MA08

100w maximum Incandescent

Weight: 2.0 lbs

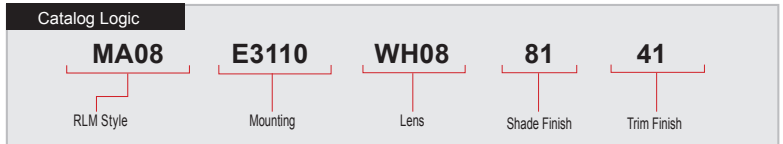

### Catalog Logic

1

2

3

4

**MA08**

**E3110**

**WH08**

### 1 MOUNTING

<b>Arm Mounts</b>	
<b>E3110</b>	
E3410	
E3510	
<b>Wall Mounts</b>	
WM905	
<b>Cord Mounts</b>	
BLC (6' black cord with 5 1/4" x 2 3/4" canopy)	
WHC (6' white cord with 5 1/4" x 2 3/4" canopy)	
<b>Stem Mount</b>	
1/2" (13/16" OD Rigid Stems with STC Flat Canopy)	
2ST6 2ST12 2ST18 2ST24 2ST36 2ST48	
2ST60 2ST72 2ST96	
3/4" (1" OD Rigid Stems with STC Flat Canopy)	
3ST6 3ST12 3ST18 3ST24 3ST36 3ST48	
3ST60 3ST72 3ST96	

### 2 LENS

NL (No Lens)
CL08 (Clear Flat Acrylic Lens)
<b>WH08 (White Flat Acrylic Lens)</b>

### 3 FINISHES

Standard Grade	Marine Grade		Standard Grade	Marine Grade	
40	NA	Raw Unfinished	53	100	Copper Clay
41	101	Black	56	109	Silver
42	102	Forest Green	61	106	Black Verde
43	114	Bright Red	70	118	Painted Chrome
44	107	White	71	105	Painted Copper
45	112	Bright Blue	72	108	Textured Black
46	123	Sunny Yellow	73	125	Matte Black
47	120	Aqua Green	76	121	Textured Architectural Bronze
49	NA	Galvanized	77	127	Textured White
50	111	Navy	78	124	Textured Silver
51	103	Architectural Bronze	10	130	Aspen Green
52	104	Patina Verde	11	131	Cantaloupe
12	133	Lilac	13	132	Putty
Premium Grade	Marine Grade		Premium Grade	Marine Grade	
81	129	Extreme Chrome	64	116	Candy Apple Red
80	117	Textured Desert Stone	65	122	Cobalt Blue
67	119	Butterscotch	82	128	Graystone
66	115	Caramel	69	113	Gunmetal Gray
68	126	Black Silver	83	134	Oil Rubbed Bronze

Consult factory for additional paint charges and availability

### 4 TRIM FINISHES

**NOTE:** Trim includes bottom trim, cap, canopy hardware and mounting.

See Shade Finish Color Chart to choose Trim Finish.

Project: \_\_\_\_\_

Fixture Type: \_\_\_\_\_ Quantity: \_\_\_\_\_

Customer: \_\_\_\_\_



**PENDANT MOUNTS**

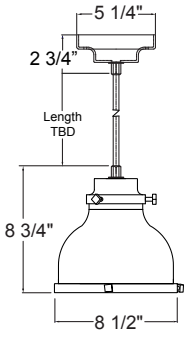

**MA08-BLC**

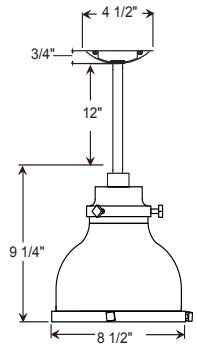

**MA08-STEM**

**ARM MOUNTS**

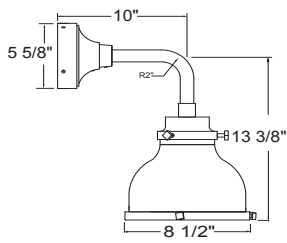

**MA08-E3110**

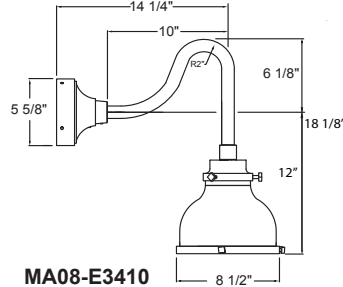

**MA08-E3410**

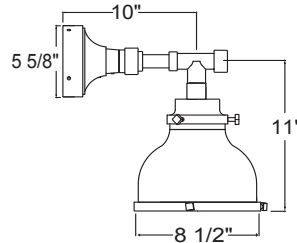

**MA08-E3510**

**WALL MOUNTS**

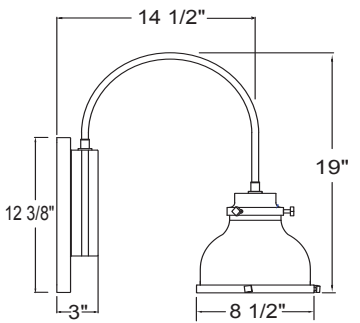

**MA08-WM905**